

DIAPHRAGM VACUUM PUMP LABOPORT® N 938.50 KT.18



Technical features

- 100 % oil-free transfer – thereby pure transferring, evacuation and compression of gases
- Connecting both pump heads in parallel and in series ensures exceptionally fast evacuation
- PTFE-coated diaphragm is ideal for aggressive/ corrosive gases and vapors
- Environmentally friendly
- High level of gas tightness

Technical data

Flow rate [m ³ /h] at atm. pressure	1.8
Flow rate [l/min] at atm. pressure	30
Ultimate vacuum [mbar abs.]	15
Operating pressure [bar]	0.5
Voltage [V]	115
Frequencies [Hz]	60
Motor protection	IP 20
Power P ₁ [W]	110
Operating current [A]	0.6
With thermal switch and power fuse	
Motors with other voltages and frequencies on request	

MATERIALS

Pump head	PPS
Diaphragm	PTFE-coated
Valves	FFPM

OTHER DATA

Weight [kg]	6.8
Hose connections	ID 10
Dimensions W x H x D [mm]	110 x 212 x 317
Permissible media and ambient temperature [°C]	+5 ... +40

ACCESSORIES

	ID
Silencer	007006
Hose connector G 1/8, ID 10, PVDF	112004
Fine control valve with vacuum gauge	112432
Spares kit	124809

Dimensions

N 938.50 KT.18

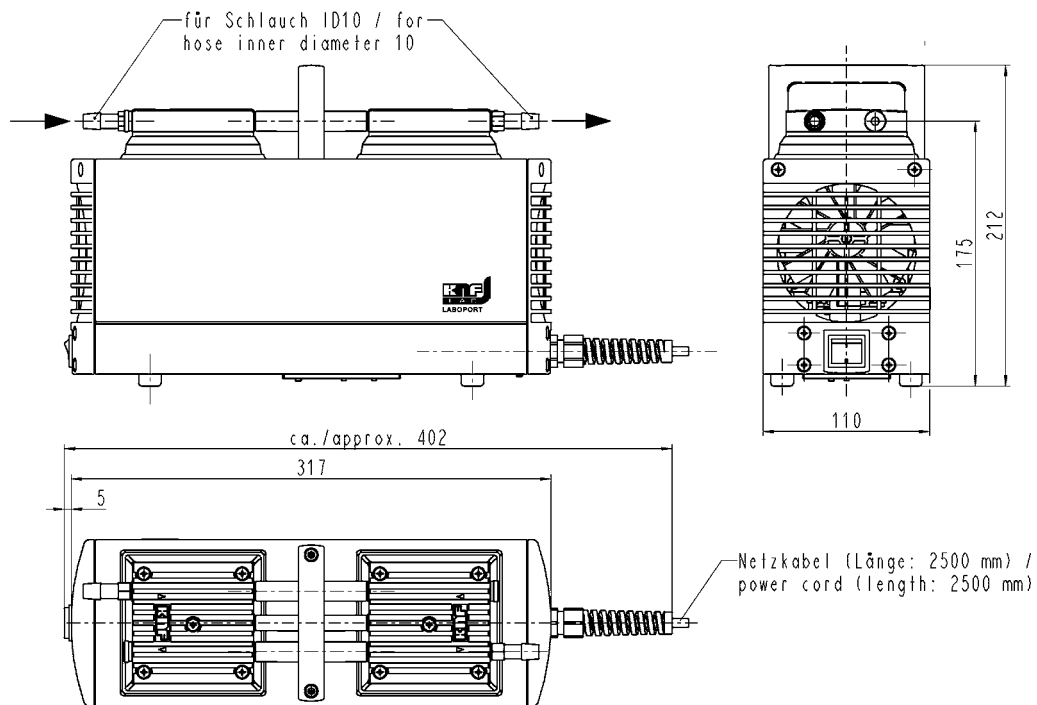

Performance characteristics

PUMP DOWN TIME FOR 10 LITER VESSEL

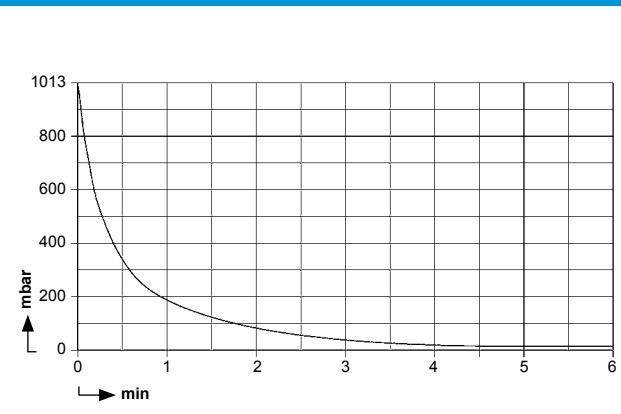

FLOW CAPACITY

